

Thermally-Enhanced High Power RF LDMOS FETs 240 W, 2110 – 2170 MHz

Description

The PTFA212401E and PTFA212401F are 240-watt LDMOS FETs designed for single- and two-carrier WCDMA power amplifier applications in the 2110 to 2170 MHz band. Features include input and output matching, and thermally-enhanced packages with slotted or earless flanges. Manufactured with Infineon's advanced LDMOS process, these devices provide excellent thermal performance and superior reliability.

PTFA212401E
Package H-36260-2

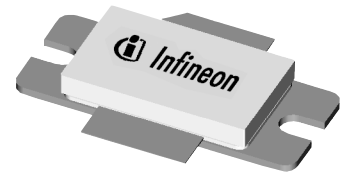

PTFA212401F
Package H-37260-2

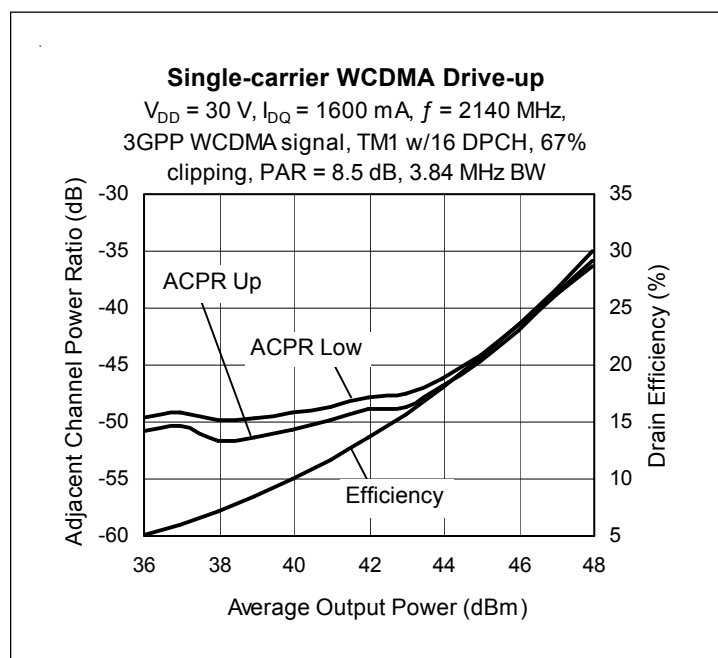

Features

- Thermally-enhanced packages, Pb-free and RoHS compliant
- Broadband internal matching
- Typical two-carrier WCDMA performance at 2140 MHz, 30 V, 3GPP signal, PAR = 8 dB
 - Average output power = 47.0 dBm
 - Linear Gain = 15.8 dB
 - Efficiency = 28%
 - Intermodulation distortion = -35 dBc
 - Adjacent channel power = -40 dBc
- Typical single-carrier WCDMA performance at 2140 MHz, 30 V, 3GPP signal, PAR = 8.5 dB
 - Average output power = 49 dBm
 - Linear Gain = 15.8 dB
 - Efficiency = 34%
 - Adjacent channel power = -33 dBc
- Typical CW performance, 2140 MHz, 30 V
 - Output power at P-1dB = 240 W
 - Efficiency = 54%
- Integrated ESD protection: Human Body Model, Class 2 (minimum)
- Excellent thermal stability, low HCI drift
- Capable of handling 5:1 VSWR @ 30 V, 240 W (CW) output power

All published data at $T_{CASE} = 25^{\circ}\text{C}$ unless otherwise indicated

ESD: Electrostatic discharge sensitive device—observe handling precautions!

RF Characteristics

Two-Carrier WCDMA Measurements (tested in Infineon test fixture)

$V_{DD} = 30\text{ V}$, $I_{DQ} = 1.6\text{ A}$, $P_{OUT} = 50\text{ W}$ average

$f_1 = 2135\text{ MHz}$, $f_2 = 2145\text{ MHz}$, 3GPP signal, channel bandwidth = 3.84 MHz, peak/average = 8 dB @ 0.01% CCDF

Characteristic	Symbol	Min	Typ	Max	Unit
Gain	G_{ps}	14.8	15.8	—	dB
Drain Efficiency	η_D	26	28	—	%
Intermodulation Distortion	IMD	—	-35.0	-33	dBc

Two-tone Measurements (not subject to production test—verified by design/characterization in Infineon test fixture)

$V_{DD} = 30\text{ V}$, $I_{DQ} = 1.6\text{ A}$, $P_{OUT} = 220\text{ W PEP}$, $f_1 = 2140\text{ MHz}$, $f_2 = 2141\text{ MHz}$, tone spacing = 1 MHz

Characteristic	Symbol	Min	Typ	Max	Unit
Gain	G_{ps}	—	15.8	—	dB
Drain Efficiency	η_D	—	38.5	—	%
Intermodulation Distortion	IMD	—	-28	—	dBc

DC Characteristics

Characteristic	Conditions	Symbol	Min	Typ	Max	Unit
Drain-Source Breakdown Voltage	$V_{GS} = 0\text{ V}$, $I_{DS} = 10\text{ mA}$	$V_{(BR)DSS}$	65	—	—	V
Drain Leakage Current	$V_{DS} = 30\text{ V}$, $V_{GS} = 0\text{ V}$	I_{DSS}	—	—	1.0	μA
	$V_{DS} = 63\text{ V}$, $V_{GS} = 0\text{ V}$	I_{DSS}	—	—	10.0	μA
On-State Resistance	$V_{GS} = 10\text{ V}$, $V_{DS} = 0.1\text{ V}$	$R_{DS(on)}$	—	0.03	—	Ω
Operating Gate Voltage	$V_{DS} = 30\text{ V}$, $I_{DQ} = 1.6\text{ A}$	V_{GS}	2.0	2.5	3.0	V
Gate Leakage Current	$V_{GS} = 10\text{ V}$, $V_{DS} = 0\text{ V}$	I_{GSS}	—	—	1.0	μA

Maximum Ratings

Parameter	Symbol	Value	Unit
Drain-Source Voltage	V_{DSS}	65	V
Gate-Source Voltage	V_{GS}	-0.5 to +12	V
Junction Temperature	T_J	200	$^{\circ}\text{C}$
Total Device Dissipation	P_D	761	W
		Above 25 $^{\circ}\text{C}$ derate by	4.35
Storage Temperature Range	T_{STG}	-40 to +150	$^{\circ}\text{C}$
Thermal Resistance ($T_{CASE} = 70^{\circ}\text{C}$, 50 W Average WCDMA)	$R_{\theta JC}$	0.23	$^{\circ}\text{C/W}$

Ordering Information

Type and Version	Package Outline	Package Description	Shipping
PTFA212401E V4	H-36260-2	Thermally-enhanced slotted flange, single-ended	Tray
PTFA212401F V4	H-37260-2	Thermally-enhanced earless flange, single-ended	Tray

Typical Performance (data taken in a production test fixture)

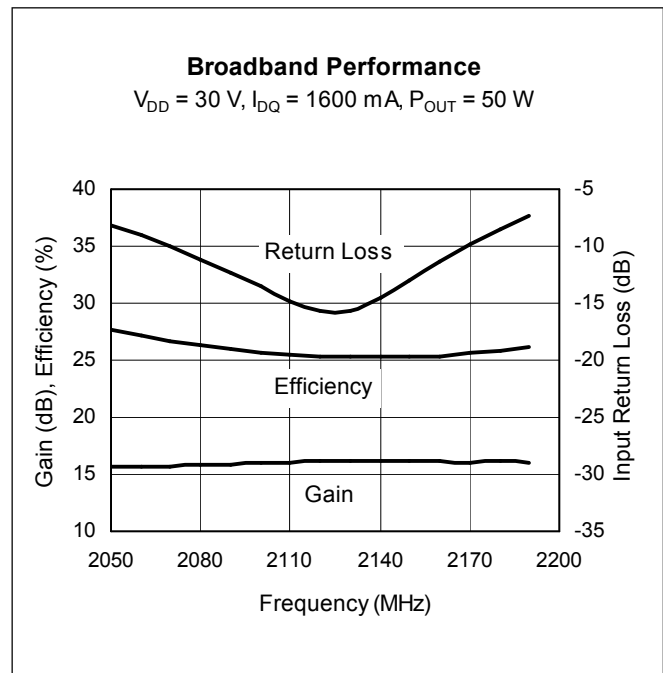
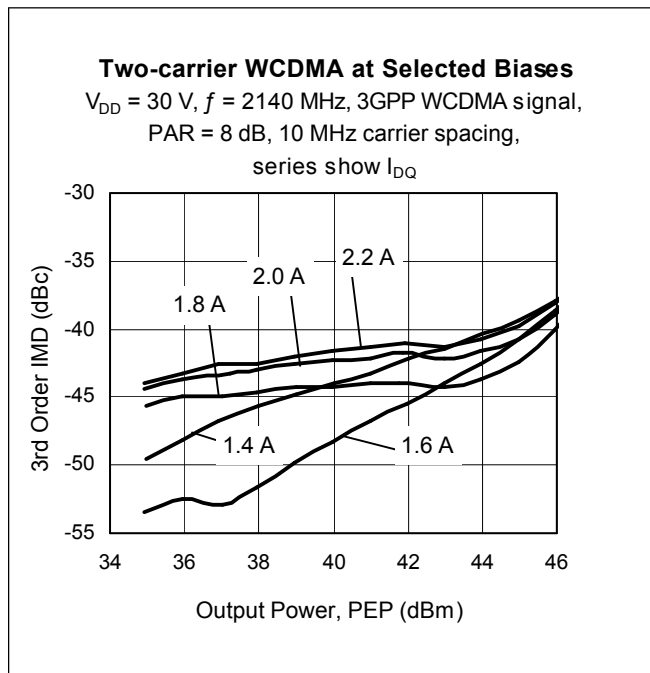

Typical Performance (cont.)

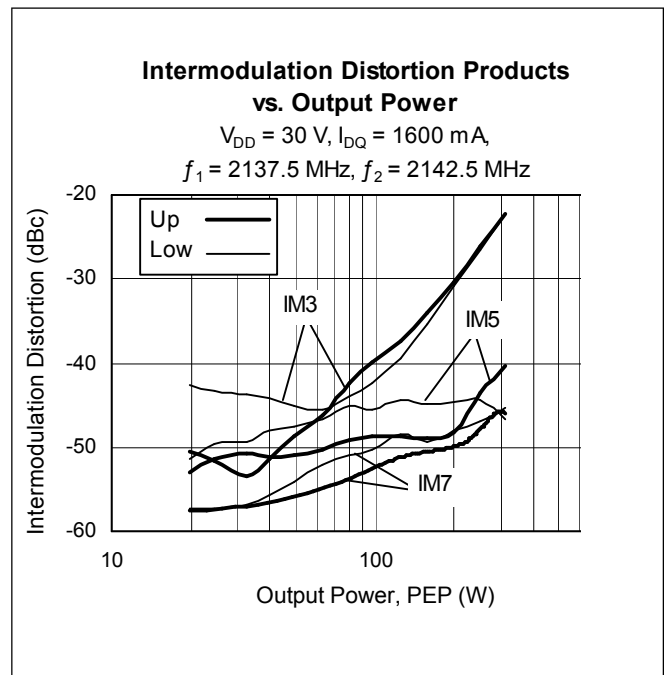
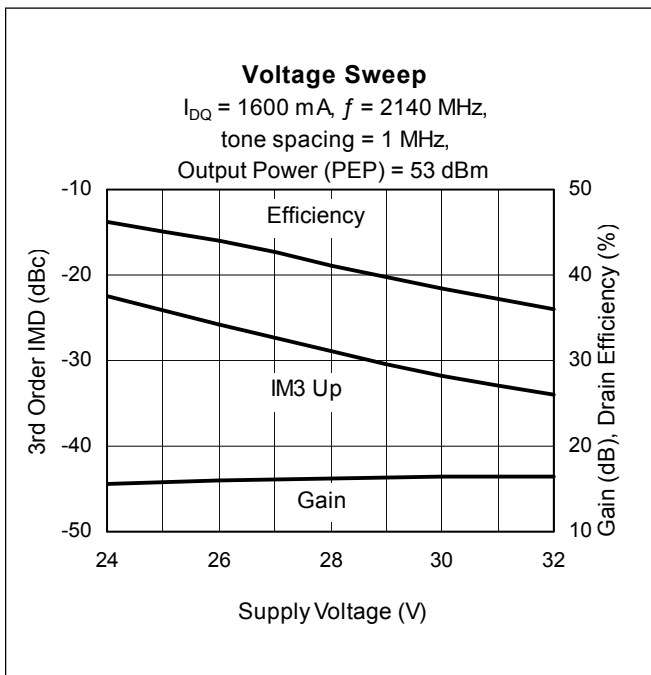
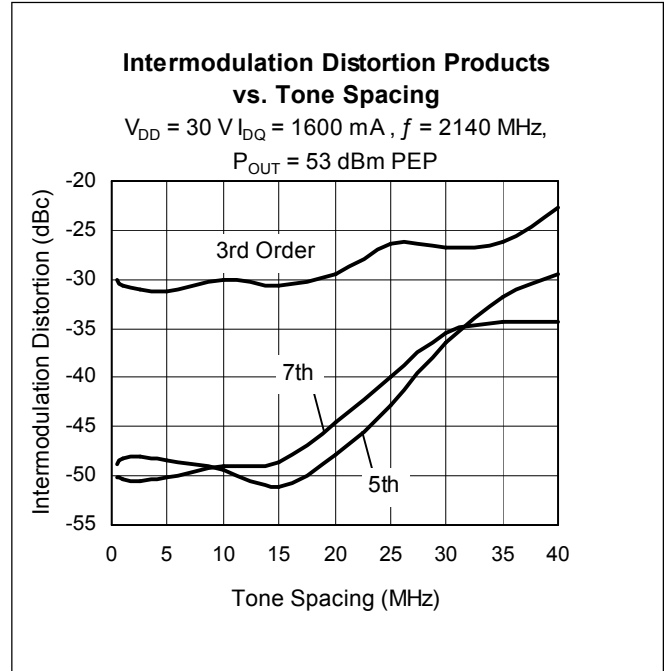
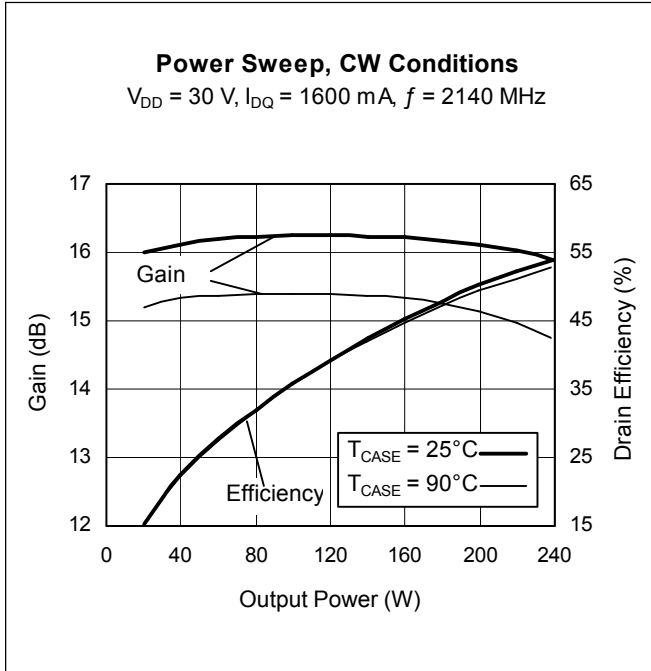

Typical Performance (cont.)

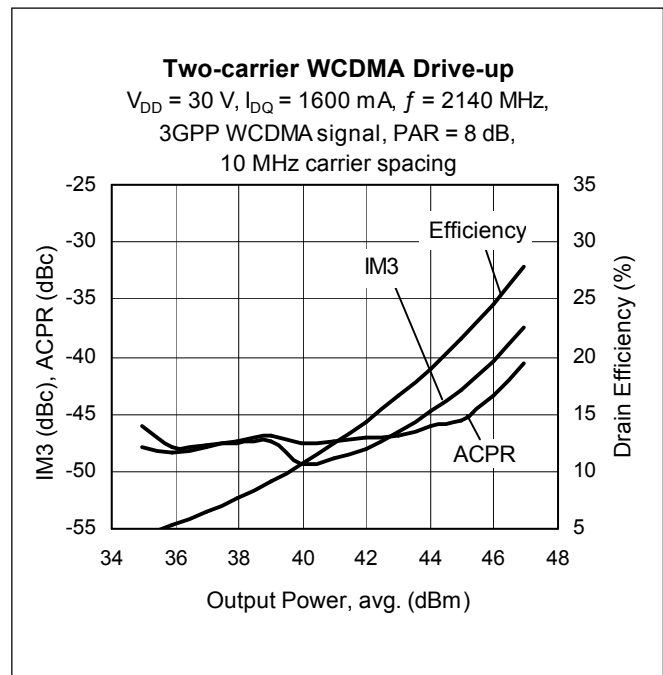
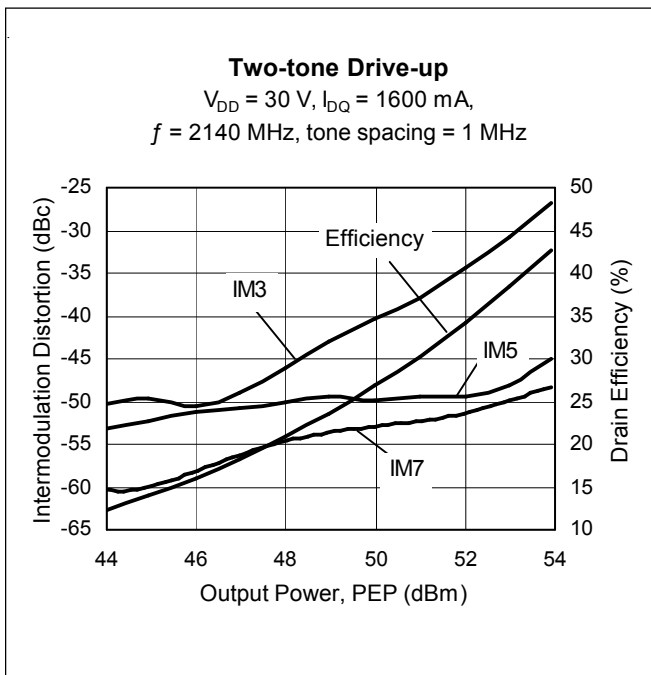
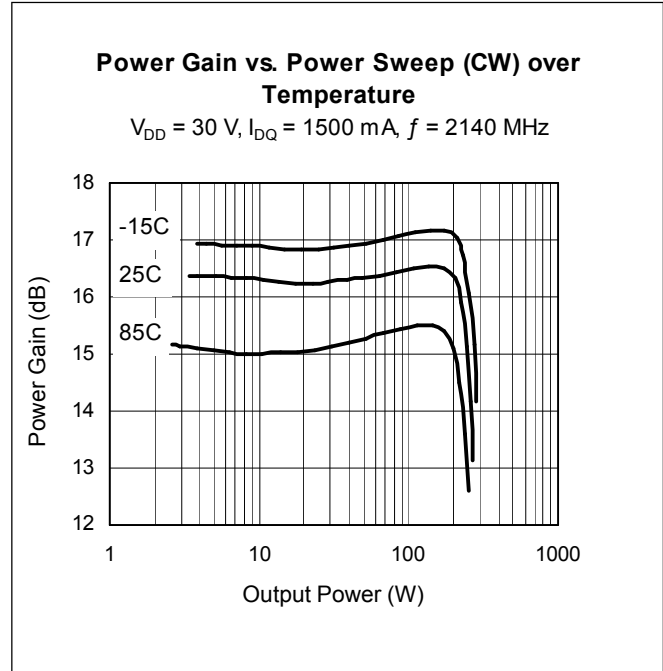
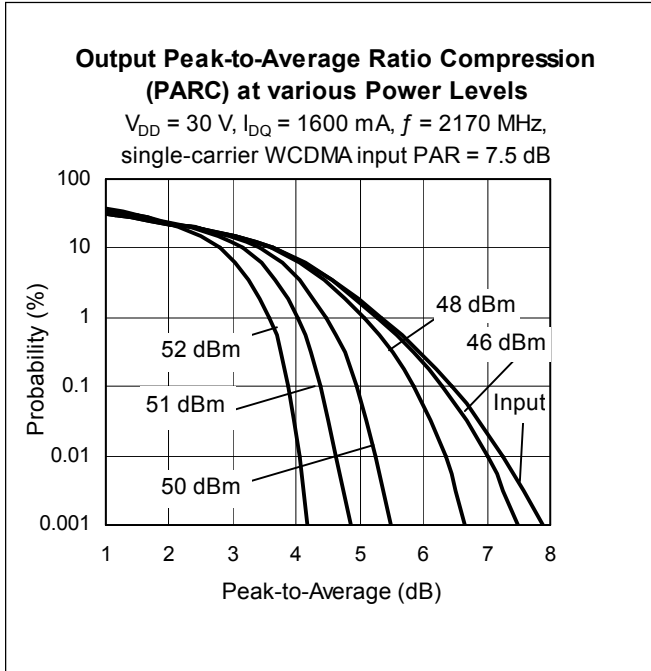

Typical Performance (cont.)

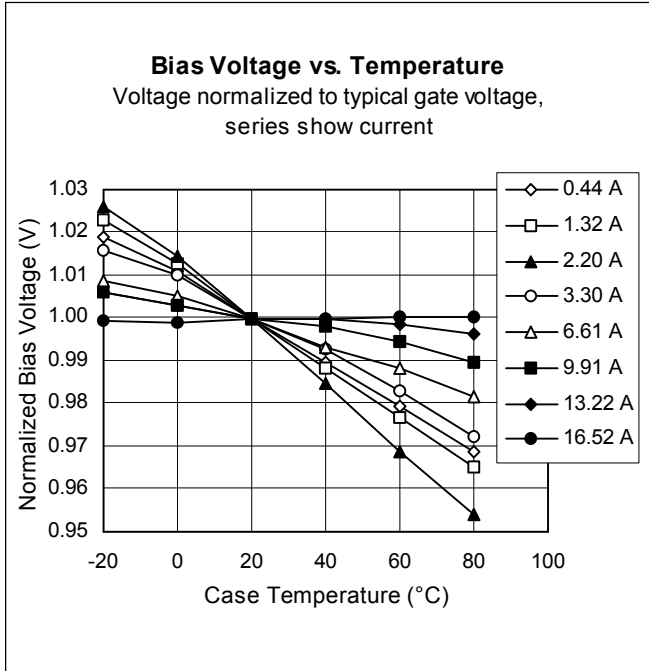

Broadband Circuit Impedance

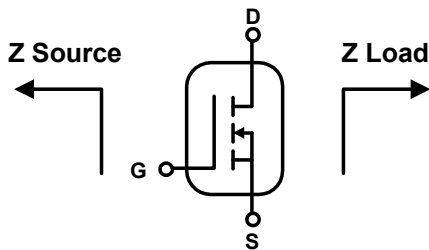

Frequency MHz	Z Source W		Z Load W	
	R	jX	R	jX
2080	10.050	-4.250	1.140	2.07
2110	9.750	-4.320	1.080	2.38
2140	9.500	-4.380	1.090	2.65
2170	9.280	-4.350	1.130	2.89
2200	9.000	-4.460	1.450	3.11

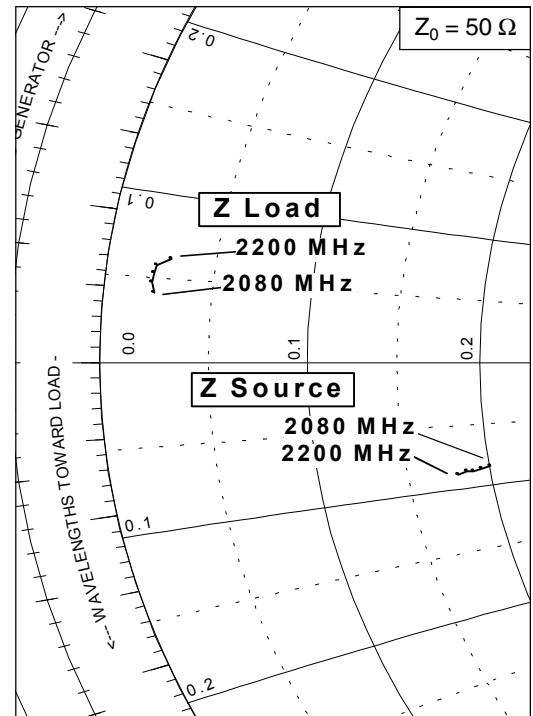

Reference Circuit

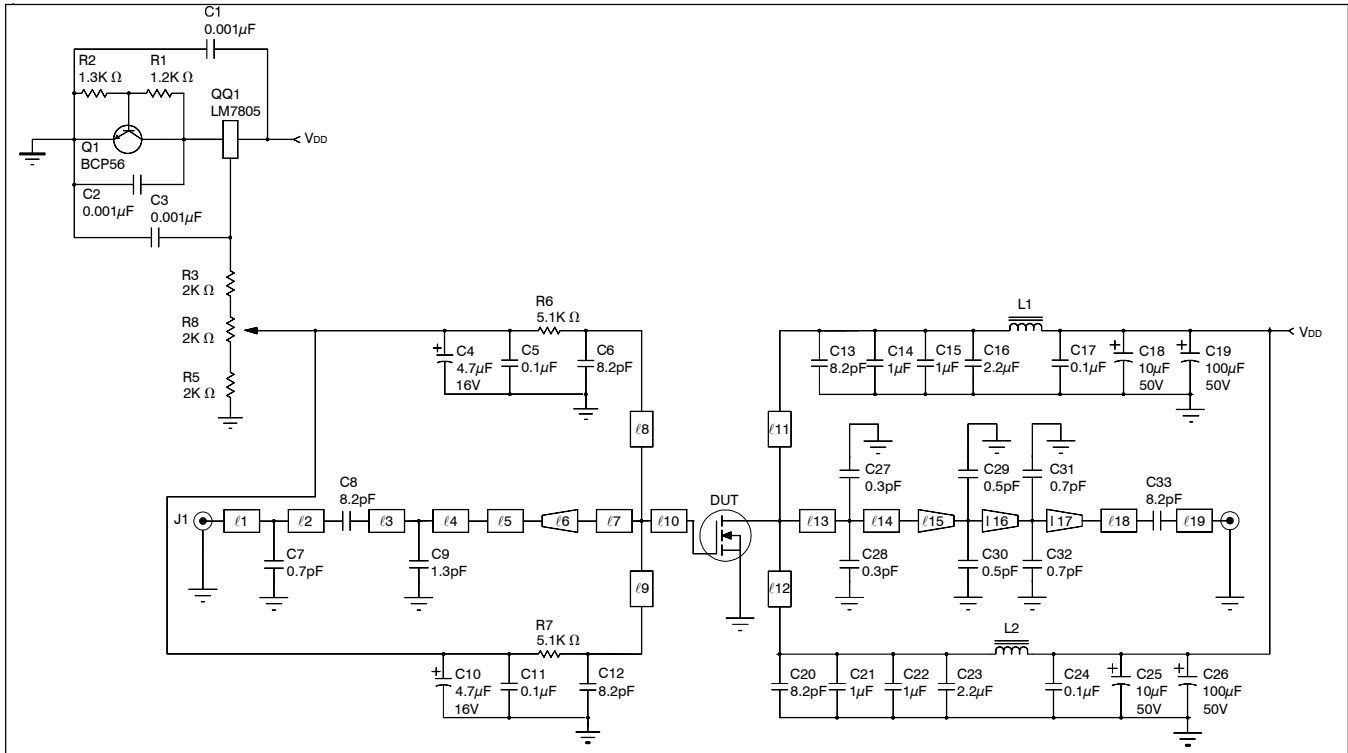

Reference circuit schematic for $f = 2140$ MHz

Circuit Assembly Information

DUT	PTFA212401E or PTFA212401F	LDMOS Transistor	
PCB	0.76 mm [.030"] thick, $\epsilon_r = 3.5$	RF-35	1 oz. copper

Microstrip	Electrical Characteristics at 2140 MHz	Dimensions: L x W (mm)	Dimensions: L x W (in.)
l_1	0.018λ , 49.9 Ω	1.55 x 1.70	0.061 x 0.067
l_2	0.022λ , 49.9 Ω	1.91 x 1.70	0.075 x 0.067
l_3	0.047λ , 49.9 Ω	3.99 x 1.70	0.157 x 0.067
l_4	0.034λ , 49.9 Ω	2.90 x 1.70	0.114 x 0.067
l_5	0.024λ , 42.8 Ω	2.01 x 2.16	0.079 x 0.085
l_6 (taper)	0.063λ , 42.8 Ω / 6.9 Ω	5.28 x 2.16 / 20.32	0.208 x 0.085 / 0.800
l_7 ,	0.043λ , 6.9 Ω	3.33 x 20.32	0.131 x 0.800
l_8, l_9	0.134λ , 59.9 Ω	11.48 x 1.04	0.452 x 0.041
l_{10}	0.029λ , 6.9 Ω	2.21 x 20.32	0.087 x 0.800
l_{11}, l_{12}	0.262λ , 51.0 Ω	22.10 x 1.65	0.870 x 0.065
l_{13}	0.042λ , 5.0 Ω	3.18 x 28.91	0.125 x 1.138
l_{14}	0.032λ , 5.0 Ω	2.41 x 28.91	0.095 x 1.138
l_{15} (taper)	0.014λ , 5.0 Ω / 6.65 Ω	1.04 x 28.91 / 21.89	0.041 x 1.138 / 0.862
l_{16} (taper)	0.026λ , 6.65 Ω / 11.68 Ω	2.03 x 21.89 / 11.43	0.080 x 0.862 / 0.450
l_{17} (taper)	0.025λ , 11.68 Ω / 40.7 Ω	2.13 x 11.43 / 2.34	0.084 x 0.450 / 0.092
l_{18}	0.017λ , 40.7 Ω	1.40 x 2.34	0.055 x 0.092
l_{19}	0.123λ , 49.9 Ω	10.24 x 1.70	0.403 x 0.067

Reference Circuit (cont.)

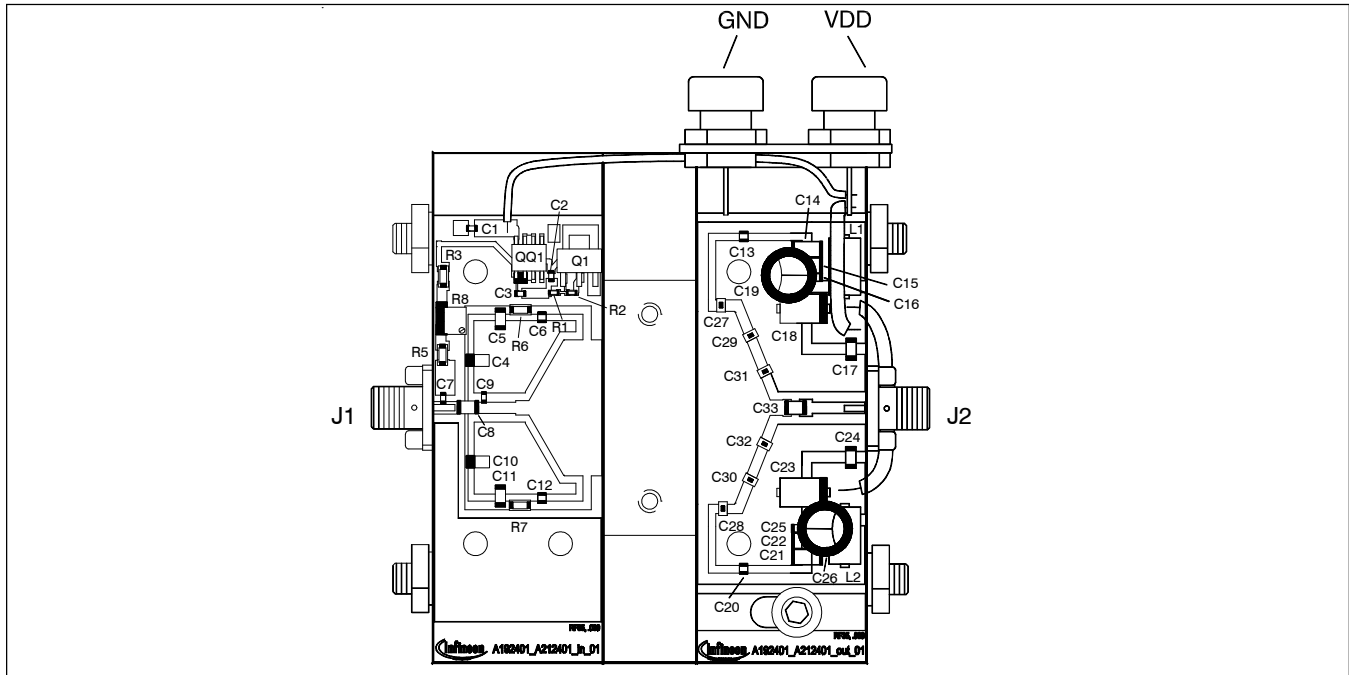

Reference circuit assembly diagram* (not to scale)

Component	Description	Suggested Manufacturer	P/N or Comment
C1, C2, C3	Capacitor, 0.001 μ F	Digi-Key	PCC1772CT-ND
C4, C10	Capacitor, 4.7 μ F, 16 V	Digi-Key	PCS3475CT-ND
C5, C11, C17, C24	Capacitor, 0.1 μ F	Digi-Key	PCC104BCT-ND
C6, C12	Ceramic capacitor, 8.2 pF	ATC	100A 8R2
C7, C31, C32	Capacitor, 0.7 pF	AVX	08051J0R7BBTTR
C8, C33	Ceramic capacitor, 8.2 pF	ATC	100B 8R2
C9	Capacitor, 1.3 pF	ATC	600S1R3BT
C13, C20	Capacitor, 8.2 pF	AVX	100A 8R2
C14, C15, C21, C22	Ceramic capacitor, 1 μ F	Digi-Key	445-1411-1-ND
C16, C23	Capacitor, 2.2 μ F	Digi-Key	445-1447-2-ND
C18, C25	Tantalum capacitor, 10 μ F, 50 V	Garrett Electronics	TPSE106K050R0400
C19, C26	Electrolytic capacitor, 100 μ F, 50 V	Digi-Key	P5571-ND
C27, C28	Capacitor, 0.3 pF	AVX	08051J0R3BBTTR
C29, C30	Capacitor, 0.5 pF	AVX	08051J0R5BBTTR
L1, L2	Ferrite, 8.9 mm	Elna Magnetics	BDS 4.6/3/8.9-4S2
Q1	Transistor	Infineon Technologies	BCP56
QQ1	Voltage regulator	National Semiconductor	LM7805
R1	Chip resistor 1.2 k-ohms	Digi-Key	P1.2KGCT-ND
R2	Chip resistor 1.3 k-ohms	Digi-Key	P1.3KGCT-ND
R3, R5	Chip resistor 2 k-ohms	Digi-Key	P2KECT-ND
R4	Chip resistor 10 ohms	Digi-Key	P10ECT-ND
R6, R7	Chip resistor 5.1 k-ohms	Digi-Key	P5.1KECT-ND
R8	Variable resistor 2 k-ohms	Digi-Key	3224W-202ETR-ND

Package Outline Specifications

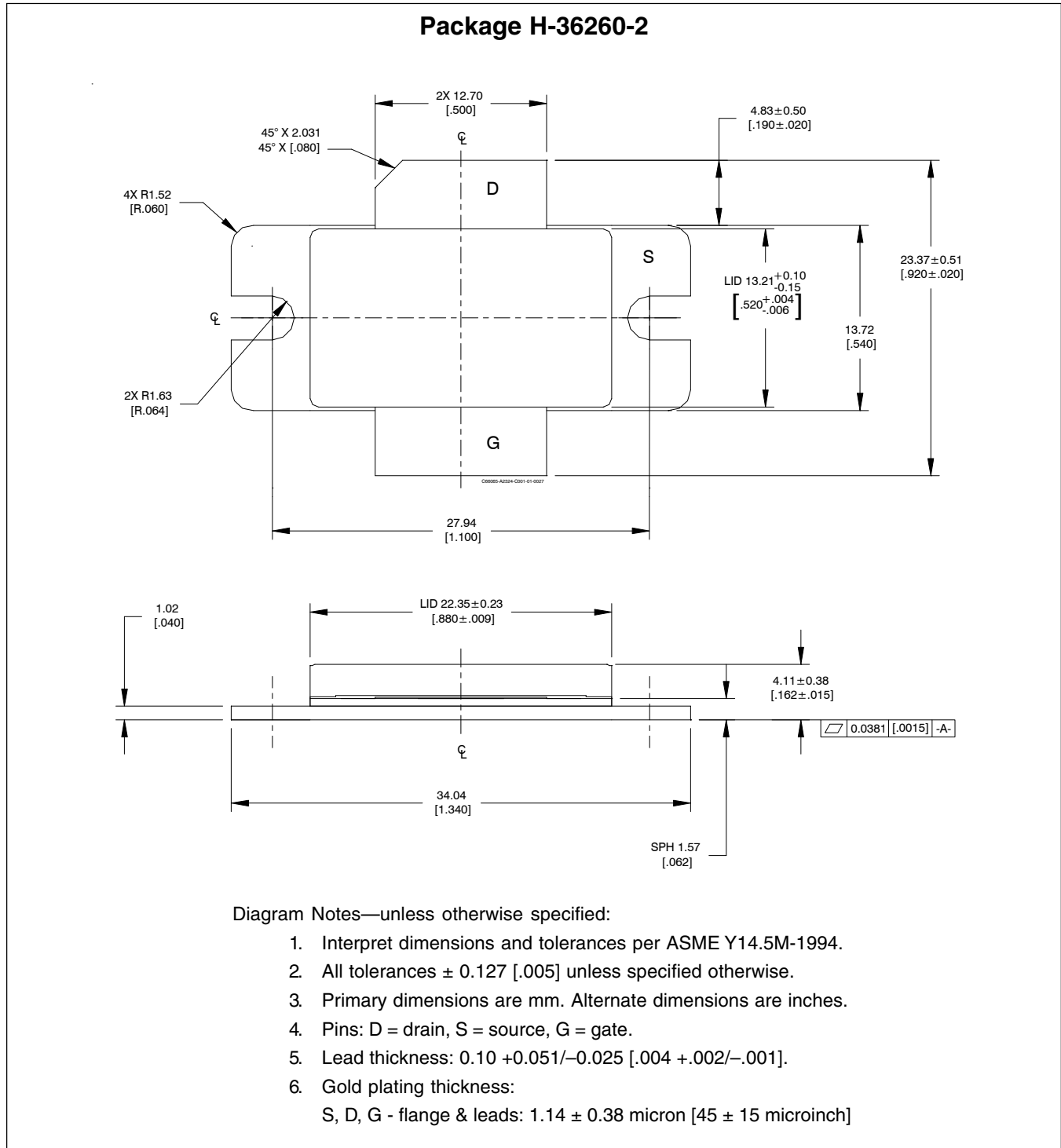

Package Outline Specifications (cont.)

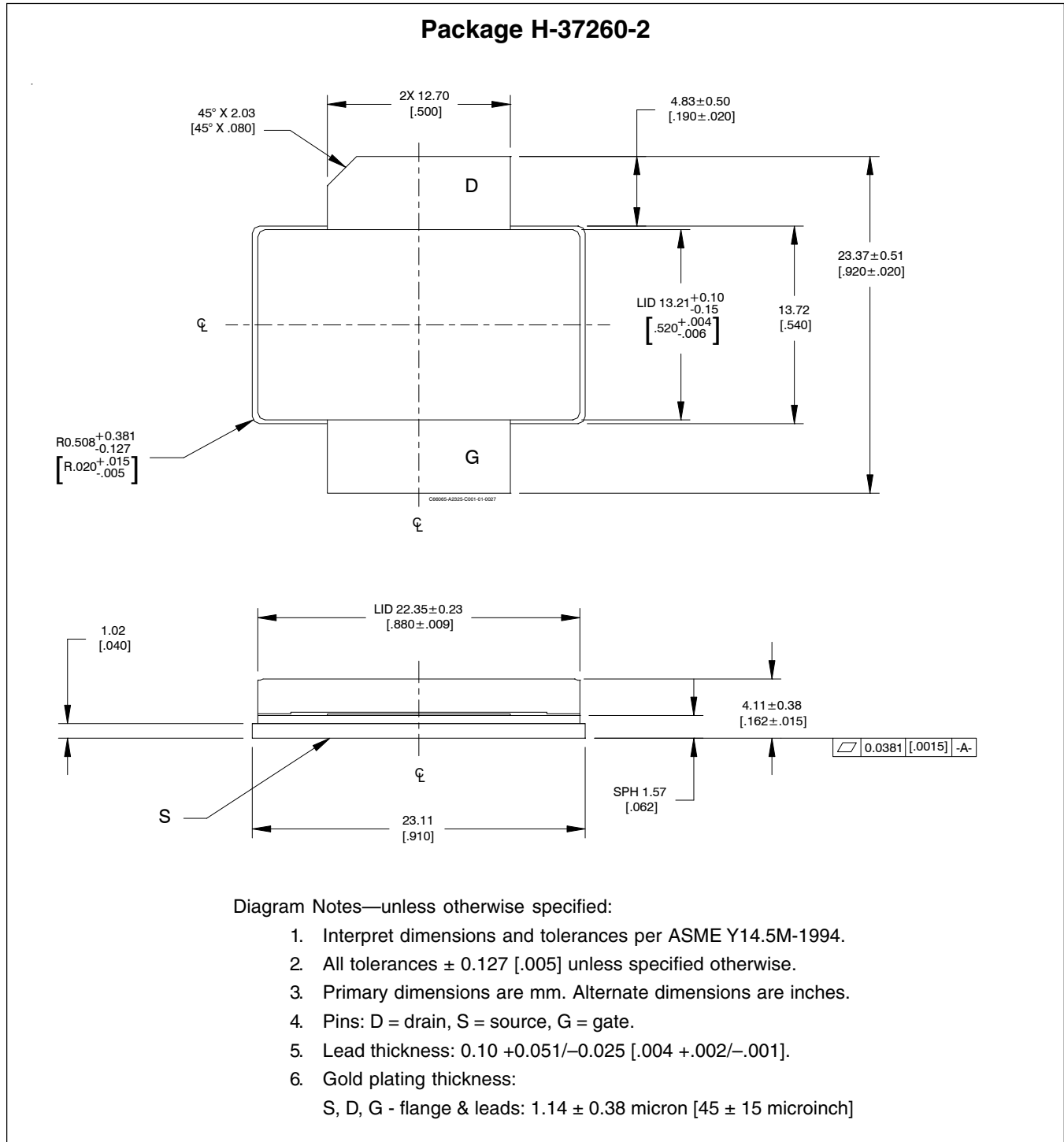

Find the latest and most complete information about products and packaging at the Infineon Internet page <http://www.infineon.com/rfpower>

Revision History: 2009-10-05

Data Sheet

Previous Version: 2009-04-01 Data Sheet

Page	Subjects (major changes since last revision)
2	Updated characteristics

We Listen to Your Comments

Any information within this document that you feel is wrong, unclear or missing at all?

Your feedback will help us to continuously improve the quality of this document.

Please send your proposal (including a reference to this document) to:

highpowerRF@infineon.com

To request other information, contact us at:

+1 877 465 3667 (1-877-GO-LDMOS) USA

or +1 408 776 0600 International

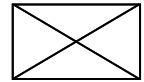

Edition 2009-10-05

Published by

Infineon Technologies AG

81726 Munich, Germany

© 2008 Infineon Technologies AG

All Rights Reserved.

Legal Disclaimer

The information given in this document shall in no event be regarded as a guarantee of conditions or characteristics. With respect to any examples or hints given herein, any typical values stated herein and/or any information regarding the application of the device, Infineon Technologies hereby disclaims any and all warranties and liabilities of any kind, including without limitation, warranties of non-infringement of intellectual property rights of any third party.

Information

For further information on technology, delivery terms and conditions and prices, please contact the nearest Infineon Technologies Office (www.infineon.com/rfpower).

Warnings

Due to technical requirements, components may contain dangerous substances. For information on the types in question, please contact the nearest Infineon Technologies Office.

Infineon Technologies components may be used in life-support devices or systems only with the express written approval of Infineon Technologies, if a failure of such components can reasonably be expected to cause the failure of that life-support device or system or to affect the safety or effectiveness of that device or system. Life support devices or systems are intended to be implanted in the human body or to support and/or maintain and sustain and/or protect human life. If they fail, it is reasonable to assume that the health of the user or other persons may be endangered.